



PFM110S-10-1000

DC MILITARY FILTER

(E.G. MIL-STD-461, DO-160, ETC.)

SPECIFICATIONS

MAX VOLTAGE: 0-500VDC

MAX CURRENT: 10A/LINE

OPERATING TEMP.: -40 TO 70C

HIPOT (L-G): 1800VDC

TYP. WEIGHT, LB(KG): 2.8(1.27)

MANUFACTURED IN ACCORDANCE WITH
THE FOLLOWING STANDARDS:

UL1283

MIL-STD-220

MIL-F-15733

LV DIRECTIVE

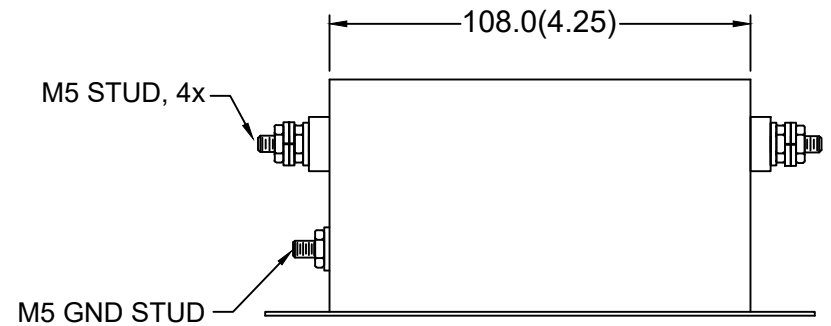
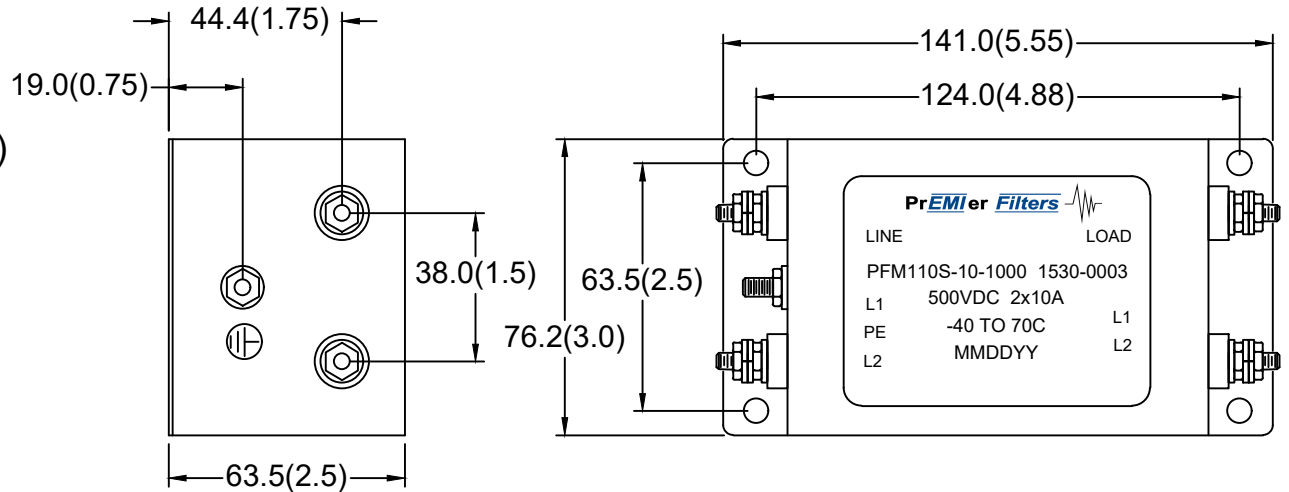

TYPICAL INSERTION LOSS, 50/50 OHM					
FREQ(HZ)	10K	100K	500K	1M	10M
CM,dB	34	50	66	64	52
DM, dB	36	52	60	62	45