



PFM110S-20-1000
 DC MILITARY FILTER
 (E.G. MIL-STD-461, DO-160, ETC.)

SPECIFICATIONS

- MAX VOLTAGE: 0-500VDC
- MAX CURRENT: 20A/LINE
- OPERATING TEMP.: -40 TO 70C
- HIPOT (L-G): 1800VDC
- TYP. WEIGHT, LB(KG): 2.8(1.27)
- MANUFACTURED IN ACCORDANCE WITH THE FOLLOWING STANDARDS:

- UL1283
- MIL-STD-220
- MIL-F-15733
- LV DIRECTIVE

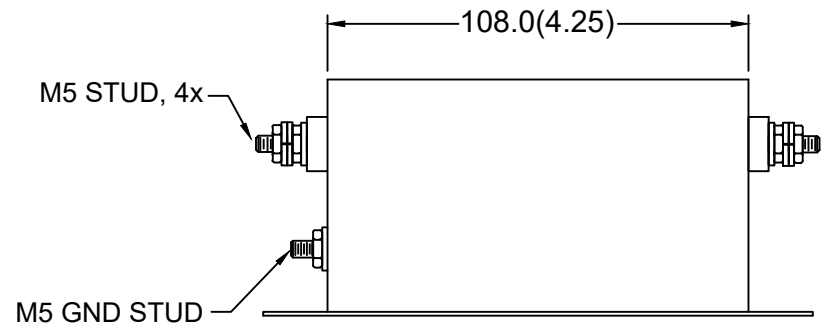
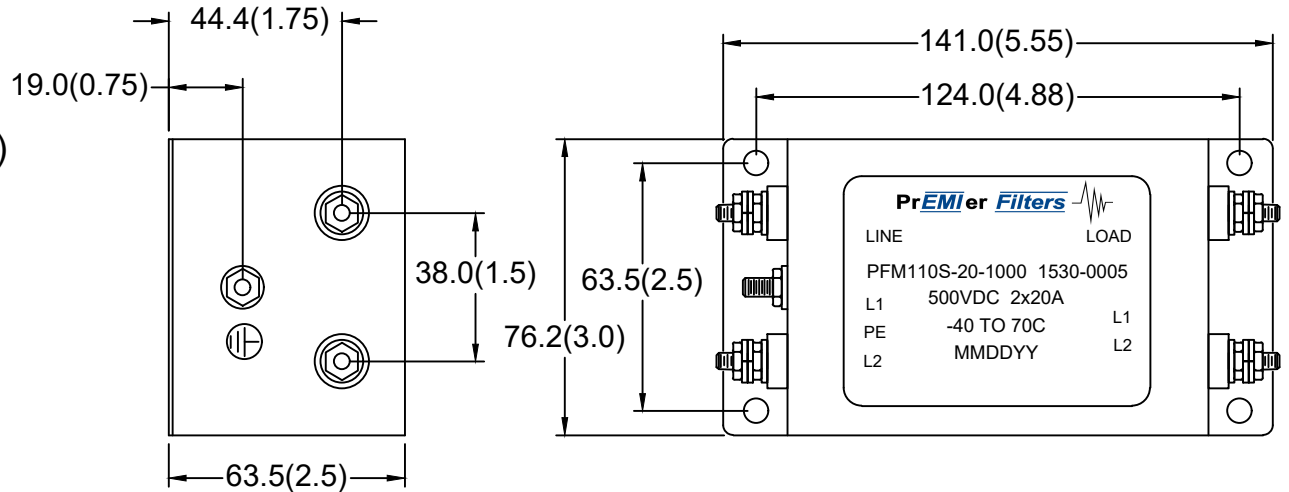

TYPICAL INSERTION LOSS, 50/50 OHM					
FREQ(HZ)	10K	100K	500K	1M	10M
CM,dB	34	50	66	64	52
DM, dB	36	52	60	62	45